



// ONE BRAND // ONE SOURCE // ONE SYSTEM

USE AND MAINTENANCE MANUAL



EXTRUDER

Model

6790LP-110V

Serial Number:

Construction year:

UNDER LAW TERMS, NO PART OF THIS MANUAL MAY BE REPRODUCED NOR COMMUNICATED TO THIRD PARTIES WITHOUT THE MANUFACTURER'S WRITTEN CONSENT.

THIS MANUAL IS MADE UP OF A NUMBER OF DOCUMENTS THAT MUST STAY WITH THE MACHINE FOR ITS ENTIRE LIFE UNTIL DEMOLITION.

TAKE CARE OF IT.

CONTENTS OF THE MANUAL

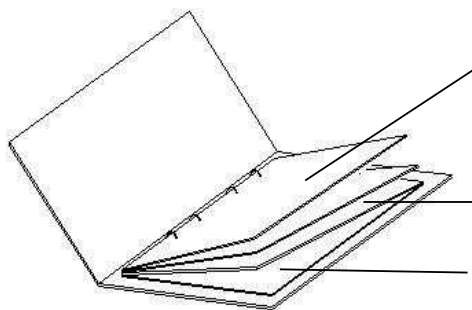

USE AND MAINTENANCE ISTRUCTIONS

Contains the description of the machine and the instructions needed for its use;

ANNEXES

*Spare part drawings
Drill manual*

1. PRELIMINARY INFORMATION 4



EXTRUDER

2. MACHINE DESCRIPTION	6
3. CONDITIONS OF USE AND GENERAL SAFETY WARNINGS.....	6
4. INSTRUCTIONS FOR USE	9
5. MACHINE MAINTENANCE.....	10
6. HANDLING AND STORAGE	11
7. DEMOLITION.....	11

1. PRELIMINARY INFORMATION

This use and maintenance manual, hereafter called "manual", contains the information needed for use and maintenance of the machine to which the manual refers.



1.1. WARNING

This manual must be considered an integral part of the machine to which it refers.

The Manual must be stored carefully by the user and must remain with the machine for the entire life of the latter.

1.2. CONFIDENTIALITY

It is forbidden to disclose, even partially, any and all of the contents in this manual to third parties not involved in the use and/or maintenance of the captioned machine.

1.3. CONDITIONS FOR GUARANTEE VALIDITY

The Manufacturer cannot be held responsible for any action or damage deriving from:

- *improper use of the machine;*
- *incorrect use of the machine not according to instructions*
- *faulty supply of any energy or fluid necessary;*
- *lack of maintenance;*
- *alterations or unauthorised action, including any for improving safety; any and all actions on the machine must be agreed with and authorised by the Manufacturer;*
- *use of non-original spare parts;*
- *failure to follow the instructions in this manual.*

1.4. INFORMATION ON MAINTENANCE ASSISTANCE

For any problem concerning use or maintenance of the machine, you can get information and technical assistance by contacting the Manufacturer's head office. When contacting the Manufacturer, please quote all the data shown on the machine identification plate.

1.5. DEFINITIONS OF PERSONNEL QUALIFICATIONS

OPERATOR

This term indicates personnel who are able to operate the machine under normal conditions of use, excluding any and all maintenance activities.

MAINTENANCE MECHANIC

A qualified technician who can work on mechanical parts of the machine in order to carry out adjustments, maintenance work and repairs as needed to guarantee good machine operation.

MAINTENANCE ELECTRICIAN

A qualified Technician who can work on the machine electrical systems to carry out maintenance and repair work as needed to guarantee good machine operation.

MANUFACTURER'S TECHNICIAN

A qualified technician made available by the Manufacturer.

1.6. DESCRIPTION OF PICTOGRAMS

Here is a list of the communication symbols appearing on the machines and in this manual.



This symbol represents a particularly important warning which if unheeded can cause important damage or serious danger for persons.



Warns of a very important note the contents of which must be absolutely taken account of.



Shown when use of the machine requires a MAINTENANCE MECHANIC



Shown when use of the machine requires a MAINTENANCE ELECTRICIAN



Shown when use of the machine requires a MANUFACTURER'S TECHNICIAN



Crushing and injury hazard to hands



Noise hazard



It is compulsory to use a hearing protection device

EXTRUDER



Hazardous substances



Crushing and injury hazards to feet



Electric shock hazard due to presence of electric tension



Burn hazard due to the presence of hot surfaces



It is compulsory to use boots with non-slip soles and reinforced toe caps



It is compulsory to use hand-protection gloves



It is compulsory to disconnect the machine supplies (electric, air etc)



It is compulsory to use suitable working clothes



Work on the machine with more than one person is prohibited



Machine adjustment and lubrication is forbidden with the machine in operation



Do not remove protections and safety devices



Work on electric parts is prohibited

2. MACHINE DESCRIPTION

TECHNICAL DATA

HYDRAULIC CHARACTERISTICS

Rubber production:	18 kg/h
Drill power rating	550 W
Electric resistance	350 W
	220/110 V
Compressed air demand:	125 NL/s
Compressed air working pressure:	6 bar
Weight:	3.8 kg
Heating temperature:	0 - 120°C

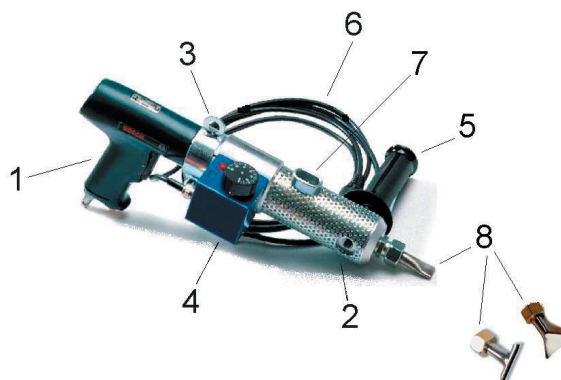

Components:

- 1 - BOSCH Drill
- 2 - extruder
- 3 - hook for mass balancer
- 4 - resistance with temperature regulation and operation Pilot Light;
- 5 - handle;
- 6 - supply cable;
- 7 - rubber infeed slot;
- 8 - nozzles

Operation characteristics



Designed and built for the infill of craters that form on tyres. Starting with a piece of a specific type of rubber, the machine heats this to a temperature set by the operator and extrudes the rubber, which the operator applies directly into the crater.

2.1. NOISE



The noise level depends on the type of drill used with the extruder; see the attached drill manual.

It is in any case the responsibility of the user to make sure that the environment where the machine is installed is not already such as to require a protection device or that it becomes such with the addition of this machine.

2.2. VIBRATION

The machine vibration depends on the type of drill used with the extruder; see the attached drill manual.

3. CONDITIONS OF USE AND GENERAL SAFETY WARNINGS

It is indispensable that the user be aware of the indications in this Manual for all the foreseen operations.



For no reason whatsoever may sealed machine organs or parts be tampered with. Any operation that might involve removal of fixed protection covers, or that require use of a specific tool, access to internal areas or adjustment of settings can lead to DANGEROUS situations and therefore such operations must be carried out only by manufacturer's personnel.

3.1. CONDITIONS OF USE

Type of environment	Industrial and/or handcraft environment conforming to general safety standards.
Environmental temperature	From -5 to +40 °C
Environmental relative humidity	20 - 60 %
Altitude	From -10 to + 1.000 m above sea level.

Lighting level in the area of use	Higher than 300 lux
Explosive atmosphere	Use of the machine in explosive atmospheres is prohibited.
Fire risk	The machine contains a heat source that can ignite fire in flammable materials.
Electromagnetic fields	The electrical system does not cause disturbances.
Environment ventilation	Ventilated environment conforming with general safety standards.
Minimum dimensions of the installation area	At least 2 m radius around the operating position.
Professional capabilities of the user	Aged 18 at least. Not disabled. See the various chapters.
Supply sources	Needs a compressed air supply at 6 bar. Needs electric power supply at 220/110V

Use of the machine under conditions differing from those stated above can be a cause of danger.

3.2. SAFETY MEASURES



Any repair or maintenance work on the machine must be done with the machine switched off and disconnected from all supplies.

Maintenance, repair and use of the machine must be entrusted to personnel trained for these jobs. The user must not, on his own initiative, carry out any operation or action on the machine that is not contemplated in this manual.

Adjustment operations are allowed only under full respect for the indications in this manual.

Main warnings on use of the machine

- Use of the machine without the safety systems is absolutely forbidden;
- Inhibition of the safety systems on the machine is absolutely forbidden;
- Do not modify the machine or its parts for any reason at all;
- Ask the manufacturer directly for any modifications to the machine;
- Cleaning and maintenance operations must be done only with the machine disconnected from all energy supplies.

In order to reach the above conditions it is necessary that:

- This Manual be available near the machine;
- Only adequately trained persons be assigned to the machine.

In the case of malfunction due to a failure to respect the above, the Manufacturer does not answer for any consequences of such failure.

Warnings regarding safety systems



- Never tamper with the safety devices.
- Do not tamper with, modify or adapt the machine.
- *Disconnect any energy supplies when the machine is not in use.*

Precautions that can reduce residual hazards

The machine has been designed and built to allow safe use.

All precautions have been taken to avoid damage to persons and property that the machine could cause during operation. Residual hazards (which cannot be removed using technical solutions) have been identified using conventional symbols. These symbols are present both on the machine and in the Instruction Manual.

The manual also contains all the information needed for correct and safe use of the machine and for identification of the qualification needed by the operator as to the work to be done.

As it is impossible for the Manufacturer to prevent all the improper and incorrect uses of the machine, any damage to persons and property due to failure to observe instructions or to incapacity or lack of knowledge on the part of the operators, is to be considered as a residual hazard.

Risks deriving from incorrect use

The instructions in this Manual, if followed and respected scrupulously by the operators, allow correct use of the machine and optimisation of its functions.



Any operation differing from those described, carried out on the personal initiative of the operator, must be considered INCORRECT USE.

Incorrect use of the machine as also the failure to respect accident prevention and safety standards, can determine dangerous conditions for persons and compromise the integrity of the machine itself.

The extent of the risks deriving from incorrect use is to be considered a consequence of the type of incorrect use and is

difficult to estimate *a priori*.

In order to avoid incorrect use of the machine it is necessary that:

- The documentation for use and maintenance of the machine be available near the work station;
- Said documentation has been read carefully and the prescriptions contained be carefully put into practice;
- *Only adequately trained personnel be assigned to the machine.*

Those responsible for users' safety must ensure that:

- There is no improper use or operation;
- There is no removal or tampering with the safety devices;
- Maintenance work is carried out regularly;
- No modification (fittings, holes and similar) is made to the machine parts for any reason, to adapt devices not foreseen by the Manufacturer;
- Exclusively original spare parts are used, particularly as concerns components with a safety function
- Cleaning operations be done using soft cloths, dry or with weak detergent solutions, after disconnecting ALL energy supplies.



Precautions that can prevent human error

To prevent error it is recommended to follow some suggestions, that can be considered forms of prevention meant to limit possible human error deriving from lack of knowledge of the most suitable procedures for the above mentioned operations:



- Supply of correct information to operators as to safety problems;
- Manipulation of the machine under safe conditions, whether packaged or unpackaged;
- Correct use of the machine;
- Detailed knowledge of the machine operation and of its limits;
- Correct use of the machine under safe conditions.







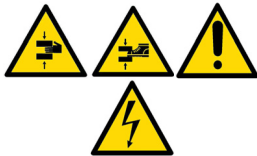

FORBIDDEN USES

- Use of the machine for functions differing from those for which it was designed and built is absolutely forbidden;
- Use of the machine with materials the characteristics of which differ from those mentioned in this Manual is forbidden.
- Use of the machine beyond the parameters of correct operation as defined during design and as described in this Manual is forbidden.
- Use of the machine by personnel whose knowledge, competence and responsibility are not adequate for the operator qualification requested, is absolutely forbidden.
- Entrusting machine control or maintenance to operators or maintenance personnel with insufficient specific training, even if provided with adequate general knowledge, competence and responsibility, is absolutely forbidden.
- Replacing worn, damaged or broken parts with spare parts other than the original ones is forbidden.
- Operating the machine with incomplete documentation is forbidden.

3.3. INDIVIDUAL PROTECTION DEVICES AND SAFETY PRESCRIPTIONS

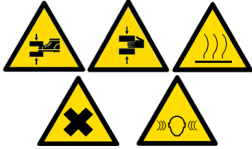
Operation	Risk	Individual protection device (IPD)	Prescription
Machine handling	<p>The machine may be dropped by the operator, leading to:</p> <ul style="list-style-type: none"> - injuries to lower limbs; - injuries to upper limbs. <p>Moreover, there may be damage to the machine and its use may no longer be safe.</p> 	<ul style="list-style-type: none"> - working clothes suitable for use in the environment where the operations take place; - machine handling gloves that guarantee a firm and safe hold; - boots with reinforced toe caps to avoid crushing; 	<ul style="list-style-type: none"> - hold the machine firmly by the handles, using gloves that guarantee a safe hold on the device. - if the machine is dropped, check it for damage and safety before using it again.

Operation	Risk	Individual protection device (IPD)	Prescription
Cleaning and maintenance on and in the machine	<p>The machine has parts that if set in motion with missing components can cause:</p> <ul style="list-style-type: none"> - injuries to lower limbs; - injuries to upper limbs; - ejection of compressed air; - burns; - electric shock. 	<ul style="list-style-type: none"> - working clothes suitable for use in the environment where the operations take place; - gloves for handling objects with sharp edges and cleaning and lubrication products; - boots with reinforced toe caps; - check also whether other IPDs are needed, according to the type of operation to be carried out (see the chapter on Maintenance). 	<ul style="list-style-type: none"> - disconnect the compressed air supply; - employ specialised personnel (see the chapter on Maintenance);  
Use of the machine	<p>Some parts of the machine can be at high temperatures that can cause slight burns.</p> <p>Careless handling of the machine can cause a loss of hold with a fall onto hands or feet.</p> <p>Overheating of the rubber leads to production of substances that represent a risk to health.</p> <p>The drill produces noise that can cause damage to hearing after prolonged exposure.</p> 	<ul style="list-style-type: none"> - clothing and protection devices as to the product and the working environment, - gloves for handling sharp objects and lubrication and cleaning products; - boots with reinforced toe caps to avoid crushing; - mask to protect airways against substances emitted by overheated rubber; - hearing protection devices. 	<ul style="list-style-type: none"> - follow the warnings and instructions in this manual and the safety procedures; see instructions for use - do not remove protection systems nor safety devices 

4. INSTRUCTIONS FOR USE

Important notes



Personnel who are employed to use this machine must be:

- aged 18 at least;
- of healthy and robust constitution.

The machine is designed for use by expert professional tyre maintenance personnel.

4.1. USE OF THE MACHINE

Before use

Before using the machine always check all components. All components must be in perfect condition, there must be no oil leaks, dents, cracks and the extruder must be complete and undamaged.

Read the attached manuals, too:

How to use the drill

See the attached manual

How to use the extruder

Connect the extruder to a power supply at 220V/110V as available.

Insert the compressed air hose into the pneumatic drill (1), turn the temperature control knob (9) setting it at 85 degrees and wait until this temperature is reached (Pilot Light off).

Take a firm hold of the extruder, insert the raw rubber strip in the slot (7), turn on the compressed air gun (1), and extrude the rubber, placing the nozzle (8) against the craters to be filled.

At the end of the working day use a strip of white rubber to clean the extruder.

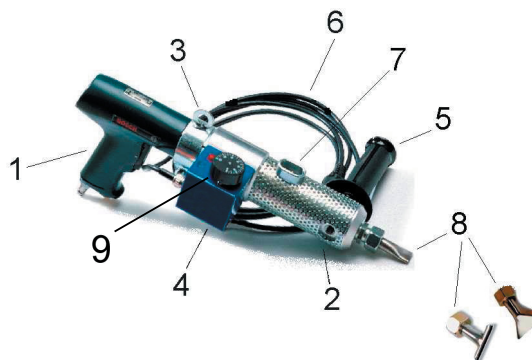

Precautions

Operate only on tyres that are locked both in rotation and in steering, to avoid uncontrollable movement.

Take a firm hold on the extruder.

Wear strong gloves and boots with reinforced toe caps.

Do not touch the extruded rubber, as it may be hot.

Wear individual protection devices as foreseen in the safety measures.



4.2. ANOMALIES AND TROUBLE SHOOTING

Anomalies to mechanical parts of the machine such as cracks, fissures, elongation are a sign of excess loads and any parts that show such anomalies must be replaced and no longer used.

If there is any anomaly, call in the Manufacturer or authorised maintenance personnel. Acting on the extruder yourself can be dangerous.



5. MACHINE MAINTENANCE

All maintenance operations must be carried out only by qualified maintenance mechanics; we suggest you call in the Manufacturer.

During maintenance operations the machine must be disconnected from the compressed air supply.



Individual protection devices (IPD)

To carry out maintenance operations safely and effectively, the following IPD are needed according to the type of operation to be carried out:

- Gloves to protect against mechanical damage;
- Eye protection to be used when cleaning with compressed air or other means;

- Boots with non-slip sole and reinforced toe caps;
- Clothing with tight sleeves around wrists;
- Masks for use when cleaning by compressed air blowing.

During maintenance operations, use the IPDs that are necessary according to the type of operation, as foreseen by current legislation.

MAINTENANCE PROGRAMME

Period	Action	How
8 hours	Control of the machine general conditions.	Inspect the general condition of the machine; all components must be in good conditions and able to guarantee efficient operation.
Monthly; even if the machine is not operating	Clean the machine and remove dust. If the machine is not in use, start it for a few minutes and operate the controls.	Vacuum the dust and/or remove with a dry rag; do not use solvents. Switch the machine on and operate the controls.
3000 hours	Replace all hoses.	Remove the old hoses and replace with new ones having the same characteristics.
	Overhaul of all mechanical parts.	Check for correct operation of all mechanical components; replace as necessary.

Maintenance Records

In order to keep the maintenance work done on the machine under control, we suggest you keep maintenance records in the form of maintenance cards. These shall be regularly updated and filed with this manual. Hereunder we suggest a table that shows the minimum necessary data for such records.

Fac-simile maintenance card to be compiled during the life of the machine

Date	Machine hours	Maintenance action	Who	Notes
	Total hours of machine operation	Description of the maintenance action taken (e.g.: oil replaced)	Signature of the maintenance operator	Any information useful at the time of the next maintenance job

6. HANDLING AND STORAGE

6.1. HANDLING

The machine and its components must be put in a case and carried using the handles on the case.

6.2. STORAGE

The machine must be stored in an area protected against weathering, at a temperature between +10 °C and +40 °C, and on the floor.

7. DEMOLITION

If the equipment is demolished, you must follow the procedures dictated by current legislation. In particular, remember to clean off the rubber.

EXTRUDER

1	Shaped Nozzle
2	Nozzle adapter
3	Screw for head cap
4	Head
5	Cooling Sleeve
6	Handle
7	Central Body
8	Clamp with screw
9	Extruder screw
10	Square joint
11	Tang
12	drill
13	Heat element 220V
14	Heat element 110V
15	Thermostat
16	Control Box
17	Screw for control box
18	Screw for thermostat
19	Knob °C (Knob °F 685/191)
20	Pilot light
22	Muffler
29	Front Bushing
30	Back Bushing

